

# 5G mmWave Revolution & New Radio

Expanding the human possibilities of technology to make our lives better

## *IEEE Webinar*

September 20<sup>th</sup> , 2017

**Dr. Amitabha Ghosh**

Head of Small Cell Research, Nokia Fellow, IEEE Fellow  
Nokia Bell Labs



**IEEE** **IEEE 5G**

AN IEEE 5G WEBINAR:  
**5G mmWave Revolution and New Radio**

With Moderation by Peggy Matson  
Join us September 20 at 11:00am ET

**REGISTER ON OUR WEBSITE**

**Amitava Ghosh**  
Nokia Fellow and Head  
Small Cell Research  
Nokia Bell Labs

The graphic features a dark purple background with a hexagonal pattern. It includes the IEEE logo, the IEEE 5G logo, a portrait of Dr. Amitabha Ghosh, and text detailing the webinar's title, moderator, date, and time. A prominent blue button with white text encourages registration on the website.

# mmWave Use cases, Challenges and Proof Points

# Value capture from 5G Evolution and Revolution towards 1 Tbs/km2 ...

## Three-pronged requirements for 5G networks

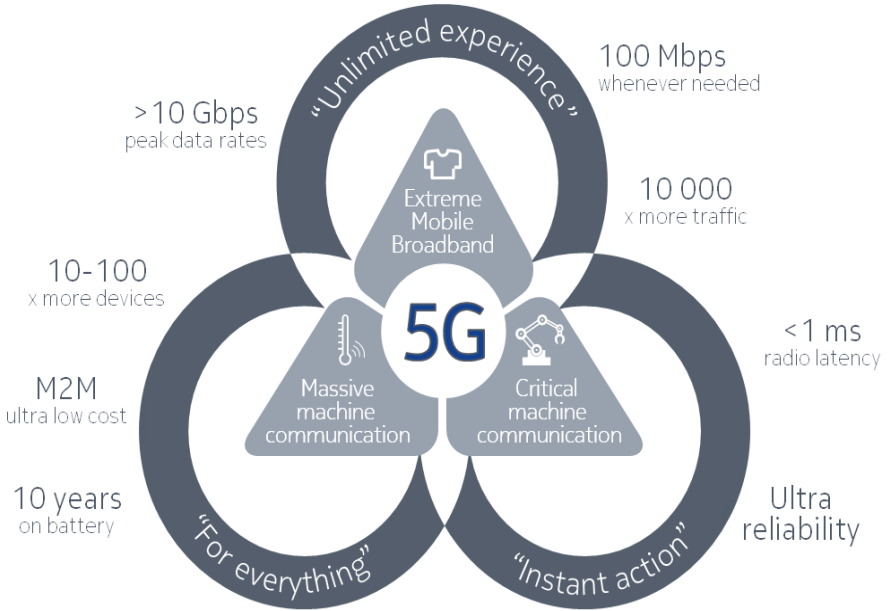
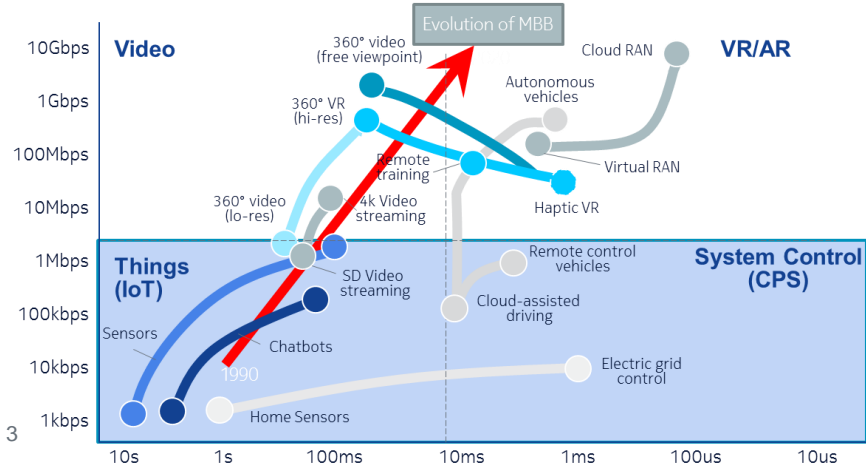
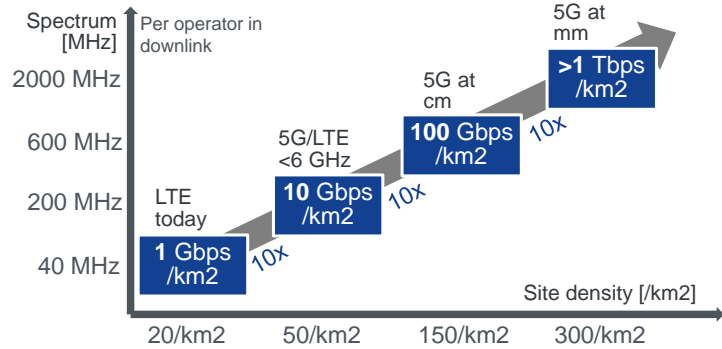

## 5G mmWave Challenges & Proof Points

- **Unique difficulties that a mmWave system must overcome**
  - Increase path loss which is overcome by large arrays (e.g., 4x4 or 8x8)
  - Narrow beamwidths, provided by these high dimension arrays
  - High penetration loss and diminished diffraction
- **Two of the main difficulties are:**
  - Acquiring and tracking user devices within the coverage area of base station using a narrow beam antenna
  - Mitigating shadowing with base station diversity and rapidly rerouting around obstacles when user device is shadowed by an opaque obstacle in its path
- **Other 5G aspects a mmWave system will need to address:**
  - High peak rates and cell edge rates ( >10 Gbps peak, >100 Mbps cell edge)
  - Low-latency (< 1ms)

## 5G Peak Rates

- 4G achieved 10-15% of the target bit rate in the first deployment and the full target four years later.
- Extrapolating to 5G would give 5 Gbps by 2020 and 50 Gbps by 2024

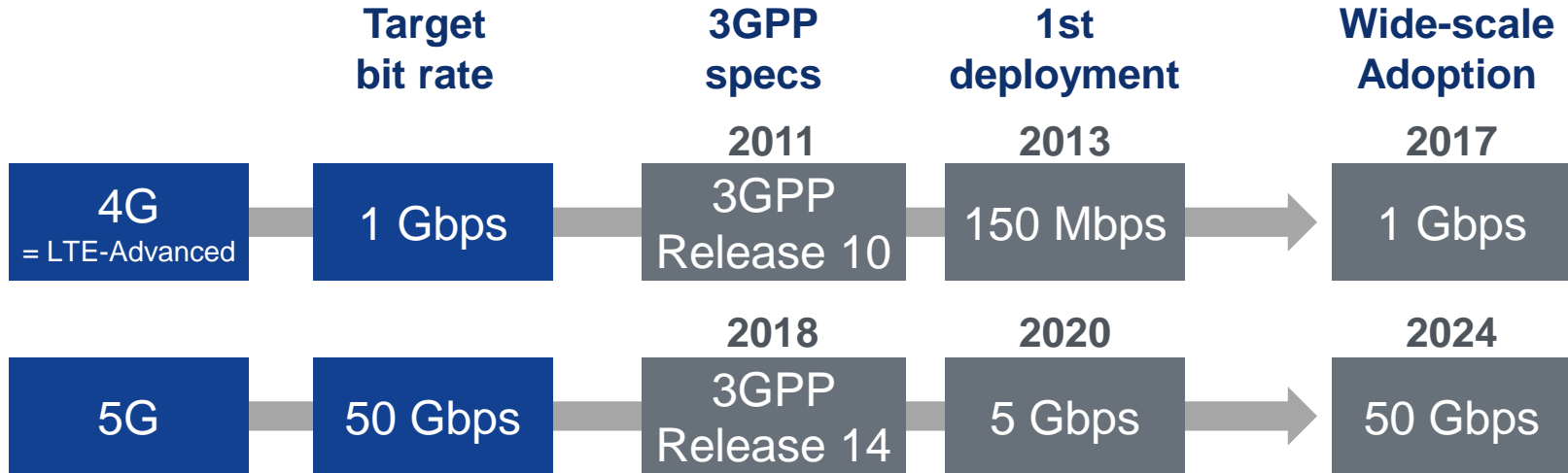



# 3GPP Schedule, mmWave Spectrum & Channel Models

# 5G (New Radio) Schedule in 3GPP

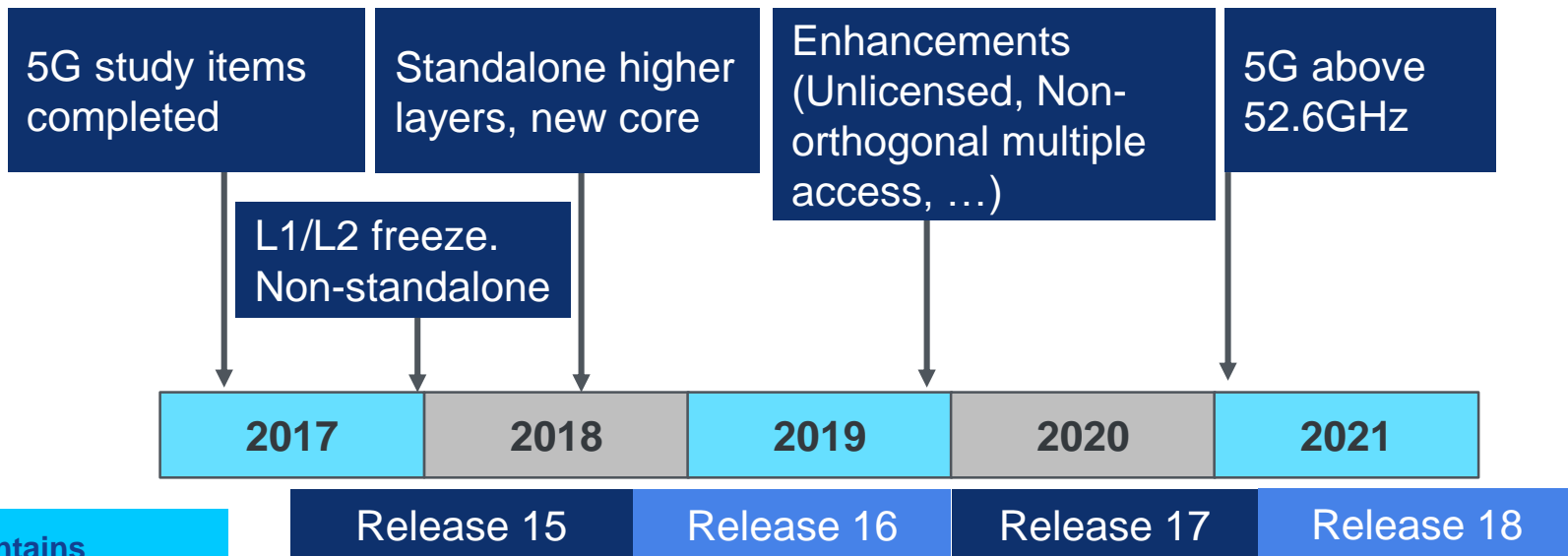

Release 15 contains intermediate ASN.1 freeze for Non-standalone in March 2018

Full ASN.1 freeze September 2018 for full 5G feature set

## 5G Schedule based on LTE History

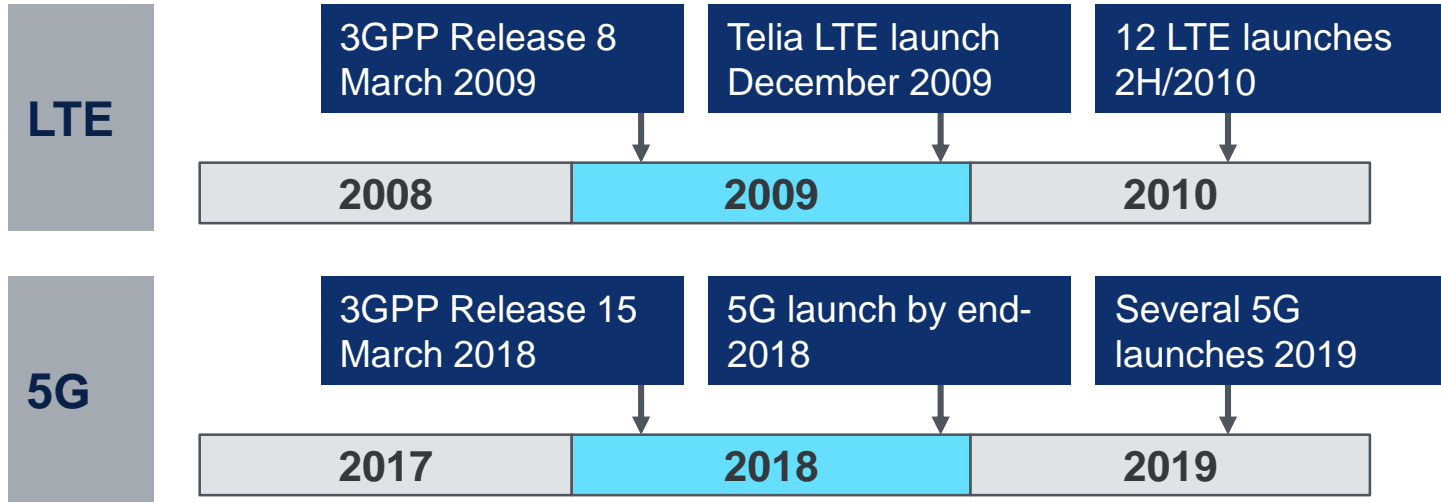

- First 3GPP LTE was launched by Telia December 2009. That was 8 months after 3GPP completed Release 8. Total 12 LTE launches during 2H/2010.
- Note the planned std phase in 3GPP for 5G is very short, only 9 months after study, which gives less development time compared to LTE specification time





# Propagation Challenges for 5G (less than 100 GHz)

- **Path loss** increases with frequency
  - However, wavelength decreases with frequency
  - Larger number of antennas possible in the same area
  - Leverage large scale arrays to mitigate the larger path loss
- **Diffraction** (e.g., the bending of rays around building corners/roofs) loss increases with frequency
  - No longer a dominant effect after around 10 GHz in outdoor channels
- **Atmospheric/rain losses** are frequency dependent
  - However: small (less than around 2.0 dB for worst-case rain) for cells radii less than 100 m even at 100 GHz
- **Reflections** seem to increase with frequency going from 6 to 100 GHz
  - Smaller objects like lamp posts more reflective as frequencies increase
  - Seems to make up for loss in diffraction in outdoor environments
- **Scattering** increases with frequency,
  - Current measurements are not showing a significant impact below 73 GHz
  - Diffuse scattering more pronounced at higher frequencies
- **Penetration loss** tends to increase with frequency
  - Highly material dependent
  - Certain materials allow even higher frequencies to pass through without much attenuation (e.g., standard glass)

## Spatial Consistency:



## Penetration Loss:

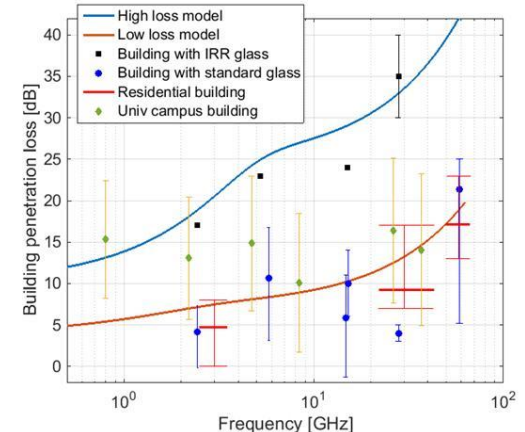

# Penetration Loss : cm/mmWave

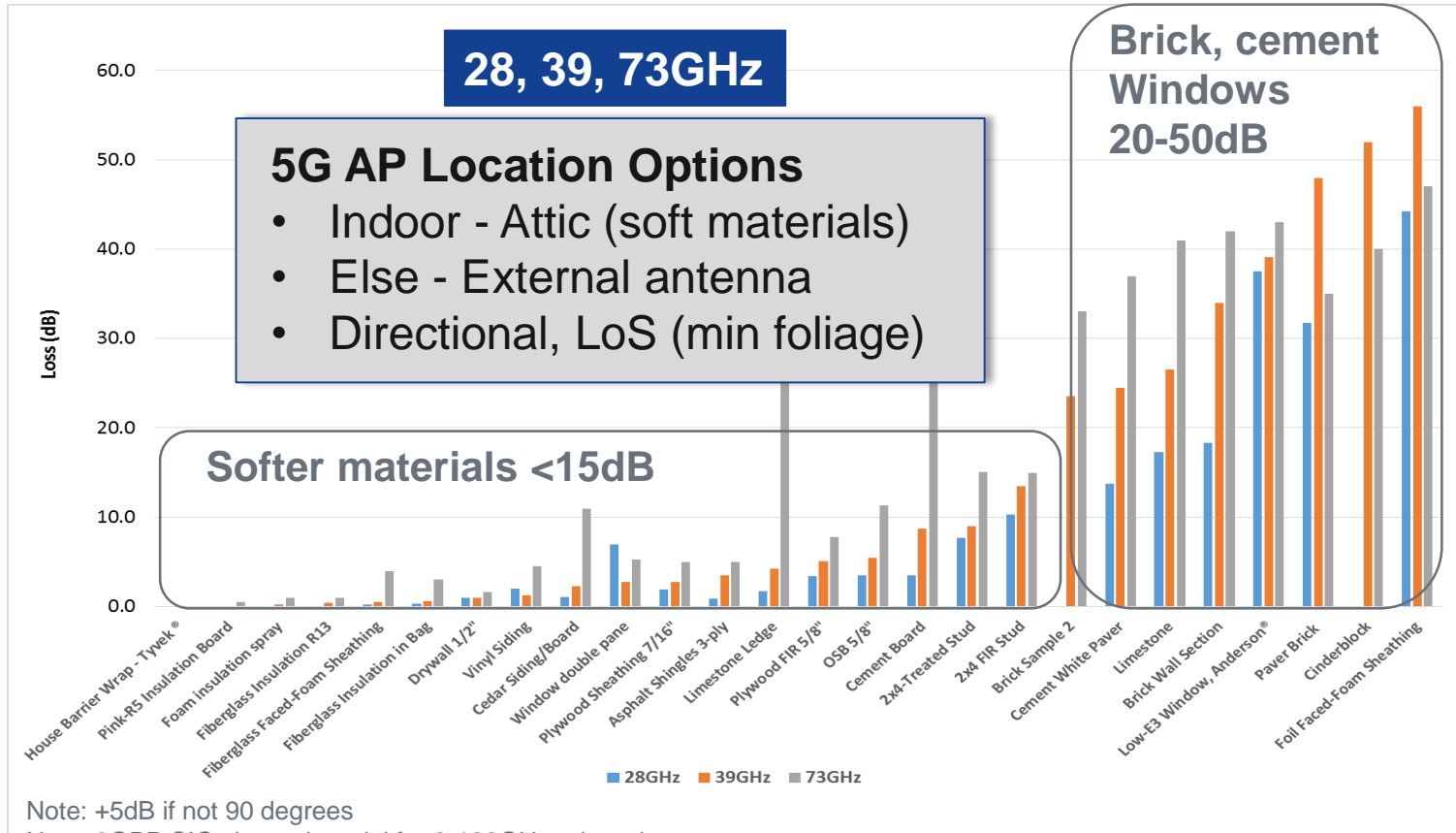

# 3GPP: 5G Channel Models

- 3GPP 5G channel model is based on 3D channel model with certain enhancements:
  - More Scenarios (RMa, UMa, UMi-Street Canyon, UMi-Open Square, Indoor-office, Indoor-Shopping mall)
  - Frequency dependent pathloss, penetration and large scale parameters are introduced
  - Additional features:
    - Large antenna and large bandwidth modelling
    - Spatial Consistency (for MU-MIMO and beam tracking simulation)
    - Blockage modelling (for mobility simulation)
    - Oxygen Absorption (for frequency in between 53GHz and 66GHz)
    - Multi-frequency correlation model (for dual-connectivity)
    - Ground reflection modelling (for LOS links when ground reflection may be significant)
- ITU Channel Model captured in ITU-R M.[IMT-2020.EVAL]
- 5G channel model is captured in TR38.901  
[http://www.3gpp.org/ftp//Specs/archive/38\\_series/38.901/38901-e11.zip](http://www.3gpp.org/ftp//Specs/archive/38_series/38.901/38901-e11.zip)

3GPP TR 38.901 V14.1.1 (2017-07)

Technical Report

3<sup>rd</sup> Generation Partnership Project;  
Technical Specification Group Radio Access Network;  
Study on channel model for frequencies from 0.5 to 100 GHz  
(Release 14)



The present document has been developed within the 3<sup>rd</sup> Generation Partnership Project (3GPP)™ and may be further elaborated for the purposes of 3GPP. The present document has not been subjected to any approval process by the 3GPP Organizational Partners and shall not be implemented. This Report is provided for future development work within 3GPP only. The Organizational Partners accept no liability for any use of this Specification. Specifications and Reports for implementation of the 3GPP™ system should be obtained via the 3GPP Organizational Partners Publications Office.



**NOKIA**

# 3GPP New Radio





# Physical Channels & Physical Signals

## PDSCH

DL shared channel

## PBCH

Broadcast channel

## PDCCH

DL control channel

## DL Physical Signals

Demodulation Ref (DMRS)  
Phase-tracking Ref (PT-RS)  
Ch State Inf Ref (CSI-RS)  
Primary Sync (PSS)  
Secondary Sync (SSS)



User Equipment

GNodeB

## PUSCH

UL shared channel

## PUCCH

UL control channel

## PRACH

Random access channel

## UL Physical Signals

Demodulation Ref (DMRS)  
Phase-tracking Ref (PTRS)  
Sounding Ref (SRS)

# 5G NR Numerology : Overview

## Numerologies with normal CP (subframe = 1msec)

	Slot Configuration 0					
Subcarrier spacing [kHz]	15	30	60	120	240*	480**
Symbol duration [us]	66.7	33.3	16.6	8.33	4.17	2.08
Nominal CP [us]	4.7	2.41	1.205	0.60	0.30	0.15
Nominal max BW [MHz]	49.5	99	198	396	397.4	397.4
Max FFT size	4096	4096	4096	4096	2048	1024
Min scheduling interval (symbols)	14	14	14	14	14	14
Min scheduling interval (slots)	1	1	1	1	1	1
Min scheduling interval (ms)	1.0	0.5	0.25	0.125	0.0625	0.0312

\*SS Block only

\*\*Not supported

## Numerologies with extended CP (subframe = 1msec)

Subcarrier spacing [kHz]	Symbol Duration[us]	Ext CP[us]	Nom max BW	FFT Size	Sched Interval (sym)	Sched Interval (slot)	Sched Interval (ms)
<b>60</b>	16.6	4.2	198	4096	12	1	0.25

# NR frame/subframe structure

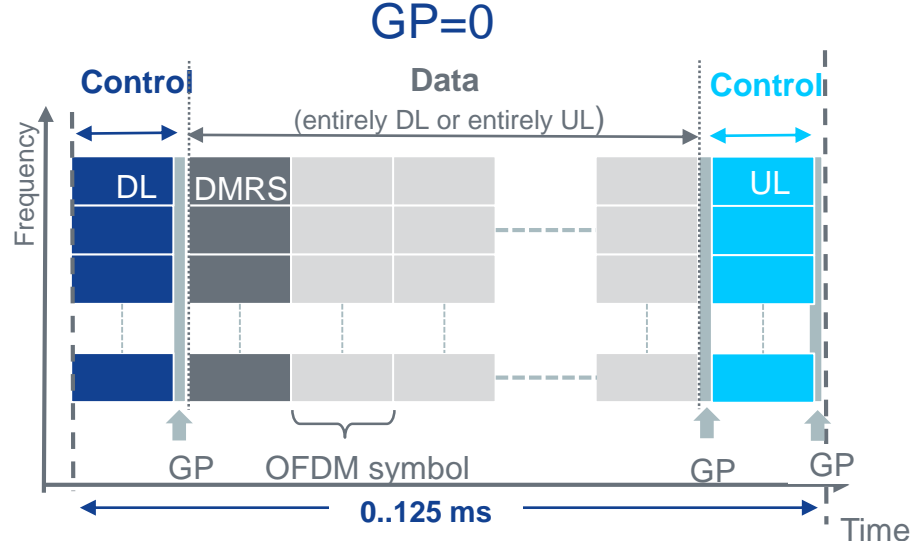
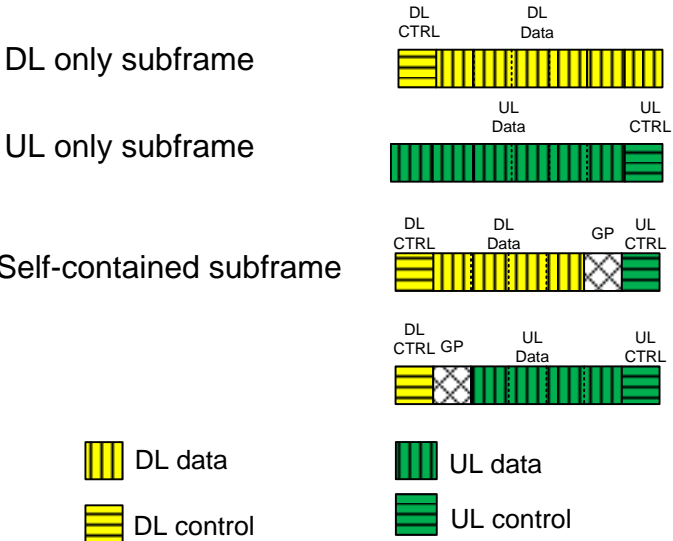

0.125ms frame with cascaded UL/DL control signals (120 KHz SC)   
 latency   
 GP = 0

Same physical layer in UL and DL   
 Flexible UL/DL

Control channel just before data   
 Energy-effective processing

# NR TDD Frame structure (120 KHz SC)

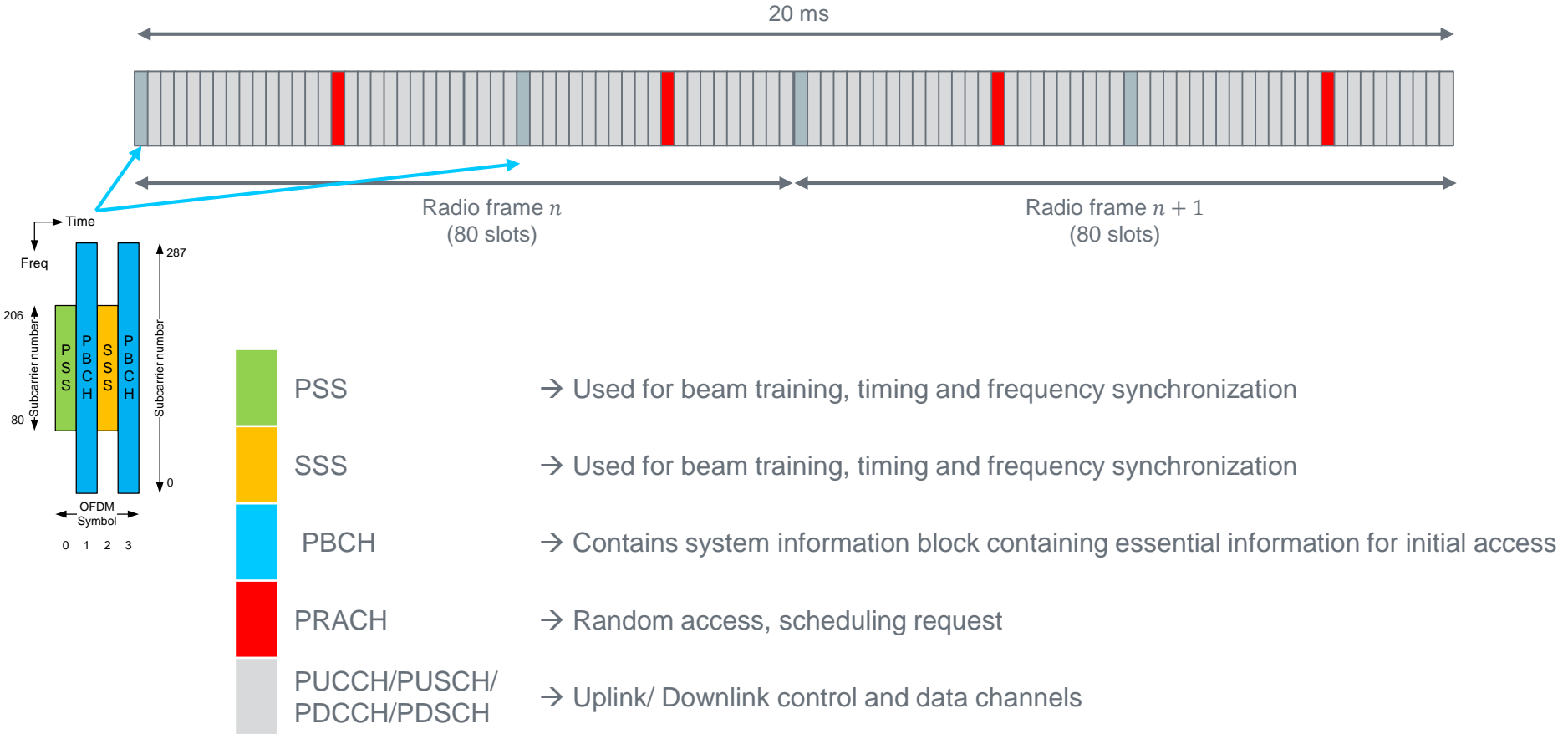

SS/PBCH Blocks : 4 OFDM Symbols and 24 PRB's

# Frame Structure (120 KHz SC) & Modulation

- 80 slots/10 ms frame
- 14 OFDM symbols/slot
- 24-275 PRBs/slot
- 12 subcarriers/PRB
- Occupied BW
  - Minm =  $24 \times 12 \times 120 = 34.56$  MHz
  - Maxm =  $275 \times 12 \times 120 = 396$  MHz

Modulation scheme	UL /DL
$\pi/2$ -BPSK	UL only, In combination with transform precoding only
QPSK	UL/DL
16QAM	UL/DL
64QAM	UL/DL
256QAM	UL/DL

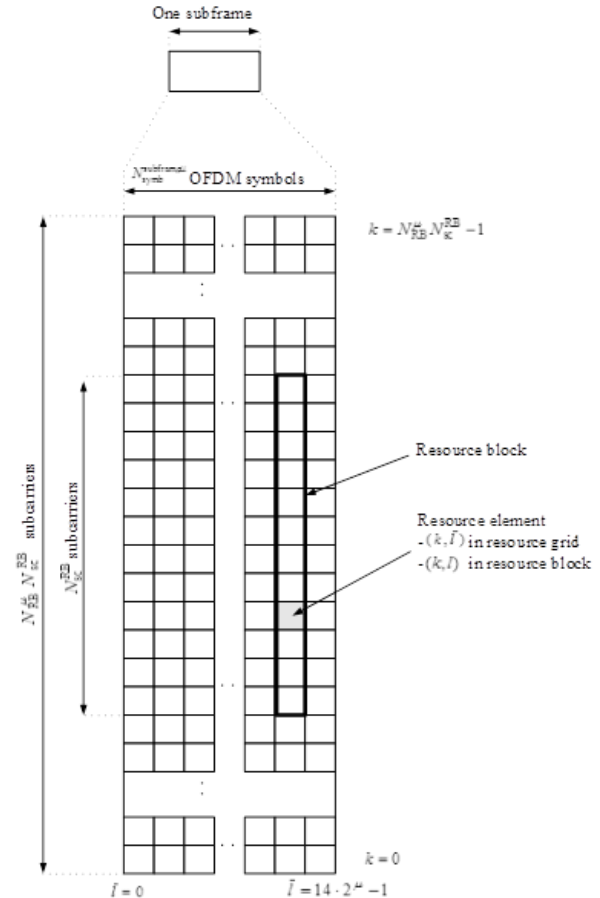



# Downlink Channels & Signals

## PDSCH and PDCCH

	PDSCH (5G)	PDSCH (LTE)	PDCCH (5G)	PDCCH (LTE)
Purpose	Transmit DL Data	Transmit DL Data	Transmit DL Control	Transmit DL Control
Waveform	OFDM	OFDM	OFDM	OFDM
Bandwidth	Numerology Dependent	Max: 1.4 / 3 / 5 / 10 / 15 / 20 MHz	Flexible, Numerology Dependent	Fixed: 1.4 / 3 / 5 / 10 / 15 / 20 MHz
Reference signals	UE-specific	Cell specific or UE-specific (Release 10)		
Phase noise compensation	Yes	No		
Modulation	Up to 256QAM	Up to 256QAM	QPSK	QPSK
Coding scheme	LDPC	Turbo	Polar	TBCC

# Uplink Channels & Signals

## PUSCH – Uplink shared channel

	PUSCH (5G)	PUSCH (LTE)
Purpose	Used to transmit uplink data and control information	Used to transmit uplink data and control information
Waveform	OFDM/SC-FDMA (Optional)	SC-FDMA
Bandwidth	See numerology	Max: 1.4 / 3 / 5 / 10 / 15 / 20 MHz
Phase noise compensation	Yes	No
Modulation	Up to 256 QAM & $\pi/2$ -BPSK	Up to 64QAM
Coding scheme	LDPC	Turbo

# Channel Coding

## eMBB Data Channel

- NR eMBB data channel adopts LDPC codes
  - Defined by parity check matrices with a structure depicted on the right
- Quasi-cyclic design
  - The parity check matrices are defined by much smaller base matrices
  - Each base matrix is either zero or a shifted identity matrix
- Enables high-throughput and low-latency hardware implementation
- Supports both Incremental Redundancy (IR) and Chase Combining (CC) HARQ

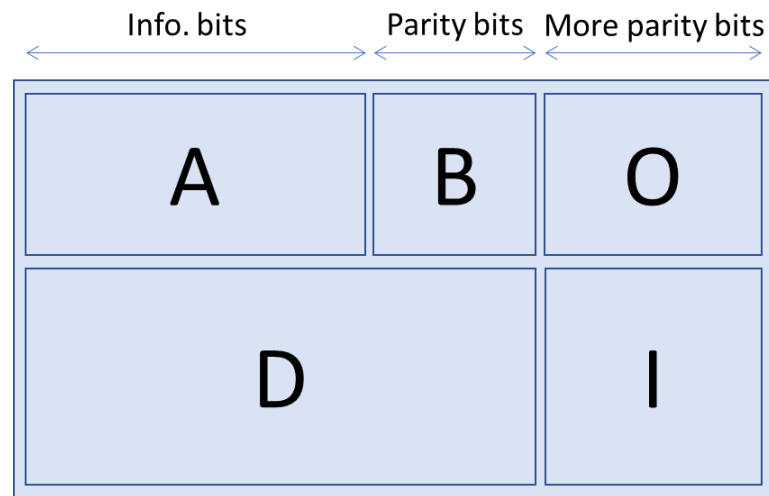

- A corresponds to (systematic) information bits
- B contains a dual diagonal structure
- O is a zero matrix
- I is an identity matrix

# Channel Coding

## eMBB Control Channel

- NR eMBB control channel uses polar codes, except for very small payloads
- Polar codes are relatively new, discovered by Prof. Arıkan in 2008
- Pure polar codes need to be concatenated with outer codes to achieve superior performance
  - Outer codes could be as simple as CRC codes
- List decoding is common and effective

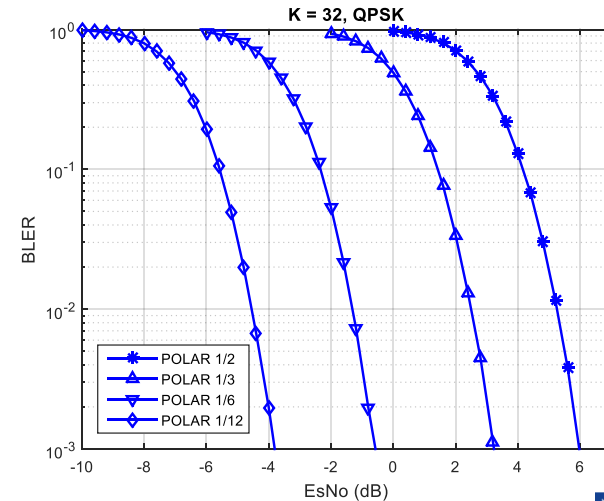
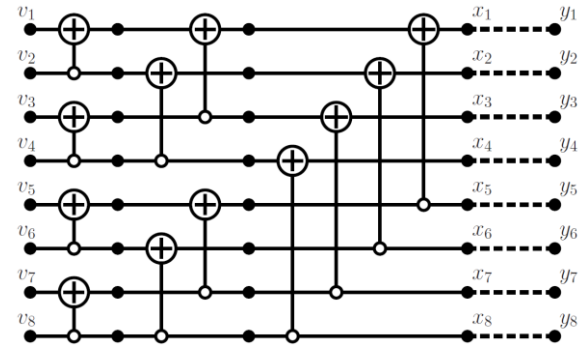

**NOKIA**

# Massive MIMO





# What is “Massive MIMO”

**Massive MIMO** is the extension of traditional MIMO technology to antenna arrays having a **large** number ( $\gg 8$ ) of controllable antennas

Transmission signals from the antennas are **adaptable** by the physical layer via gain or phase control

Not limited to a particular implementation or TX/RX strategy



## **Enhance Coverage:**

High Gain Adaptive Beamforming  
→ Path Loss Limited ( $>6\text{GHz}$ )

## **Enhance Capacity:**

High Order Spatial Multiplexing  
→ Interference-limited ( $<6\text{GHz}$ )

## Massive MIMO: Why Now?

### Capacity Requirements

Most Macro Networks will become congested

Spectrum < 3GHz and base sites will run out of capacity by 2020

### Coverage Requirements

Below 6GHz:  
desire to deploy LTE/NR on site grids sized for lower carrier frequencies

Above 6GHz:  
Large Bandwidths but poor path loss conditions

### Technology Capability

Active Antennas are becoming technically and commercially feasible

Massive MIMO requires Active Antenna technology

### 3GPP Spec Support

3GPP supports Massive MIMO in Rel-13/14 for LTE and Rel-15 for NR/5G

3GPP-New-Radio will be a “beam-based” air interface

# Antenna Array Architectures for scalable flexible MIMO

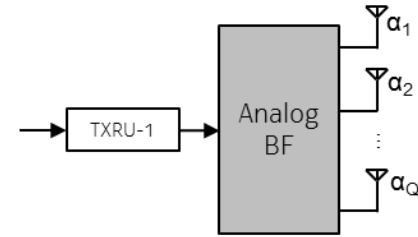
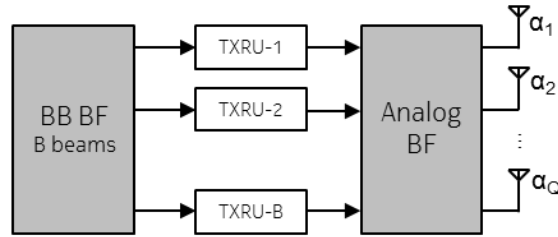
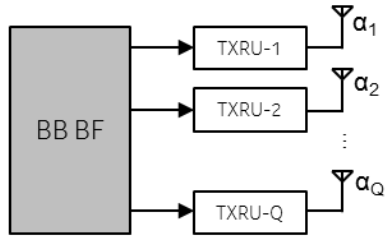

Digital (Baseband) beamforming	Hybrid beamforming	Analog beamforming
Adaptive TX/RX weights at Baseband	Adaptive TX/RX weights at both Analog and Baseband domains	Adaptive TX/RX weights at RF to form a beam
Each antenna element or antenna port has a transceiver unit High number (8->) of transceiver units	Each RF beam has a transceiver unit; Moderate number of transceiver units for capacity (e.g. up to 8)	One transceiver unit and one RF beam with high antenna gain (coverage)
“Frequency-Selective” beamforming	Combination of Analog and Baseband beamforming	“Frequency-Flat” beamforming
Best for capacity and flexibility (subject to high power consumption & cost characteristics when bandwidth increases)	Optimization between both coverage and capacity	Best for coverage (low power consumption & cost characteristics)

## MIMO in 3GPP

Release 8	Release 9	Release 10	Release 11
<ul style="list-style-type: none"><li>• 4x4MIMO</li><li>• 4x2MIMO</li><li>• 8RX uplink</li><li>• Uplink CRAN</li></ul>	<ul style="list-style-type: none"><li>• 8TX TM8</li></ul>	<ul style="list-style-type: none"><li>• 8TX TM9</li></ul>	<ul style="list-style-type: none"><li>• Downlink CoMP (TM10)</li></ul>
Release 12	Release 13	Release 14	Release 15+
<ul style="list-style-type: none"><li>• Downlink eCoMP</li><li>• New 4TX codebook</li></ul>	<ul style="list-style-type: none"><li>• Massive MIMO 16TX</li></ul>	<ul style="list-style-type: none"><li>• Massive MIMO 32TX</li></ul>	<ul style="list-style-type: none"><li>• 5G massive MIMO 64TX+</li></ul>

# Massive MIMO in 3GPP New Radio – Beam Based Air Interface

## Beamformed Control Channels

Lower carrier frequencies (digital arch)  
- Single-beam

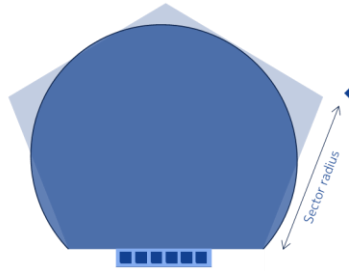

Higher carrier frequencies (hybrid/analog  
beamforming architecture)  
- Multi-beam

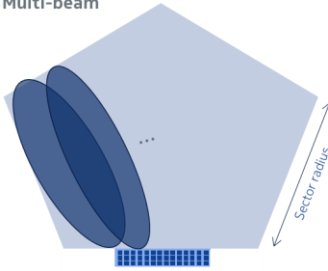

## Beam Scanning

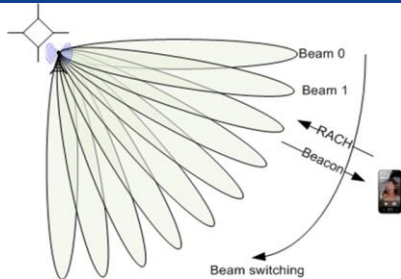

## Beam Management

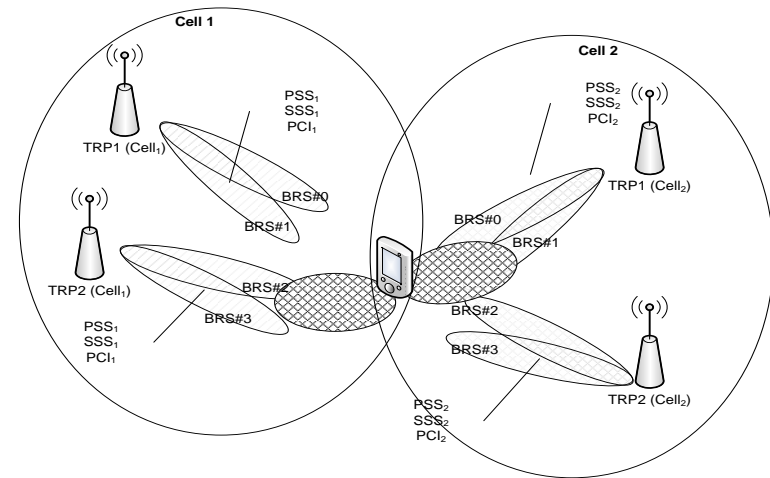

- Acquisition and maintenance of a set of beams for TX and RX at base and UE
- CoMP is built in

# Initial Access

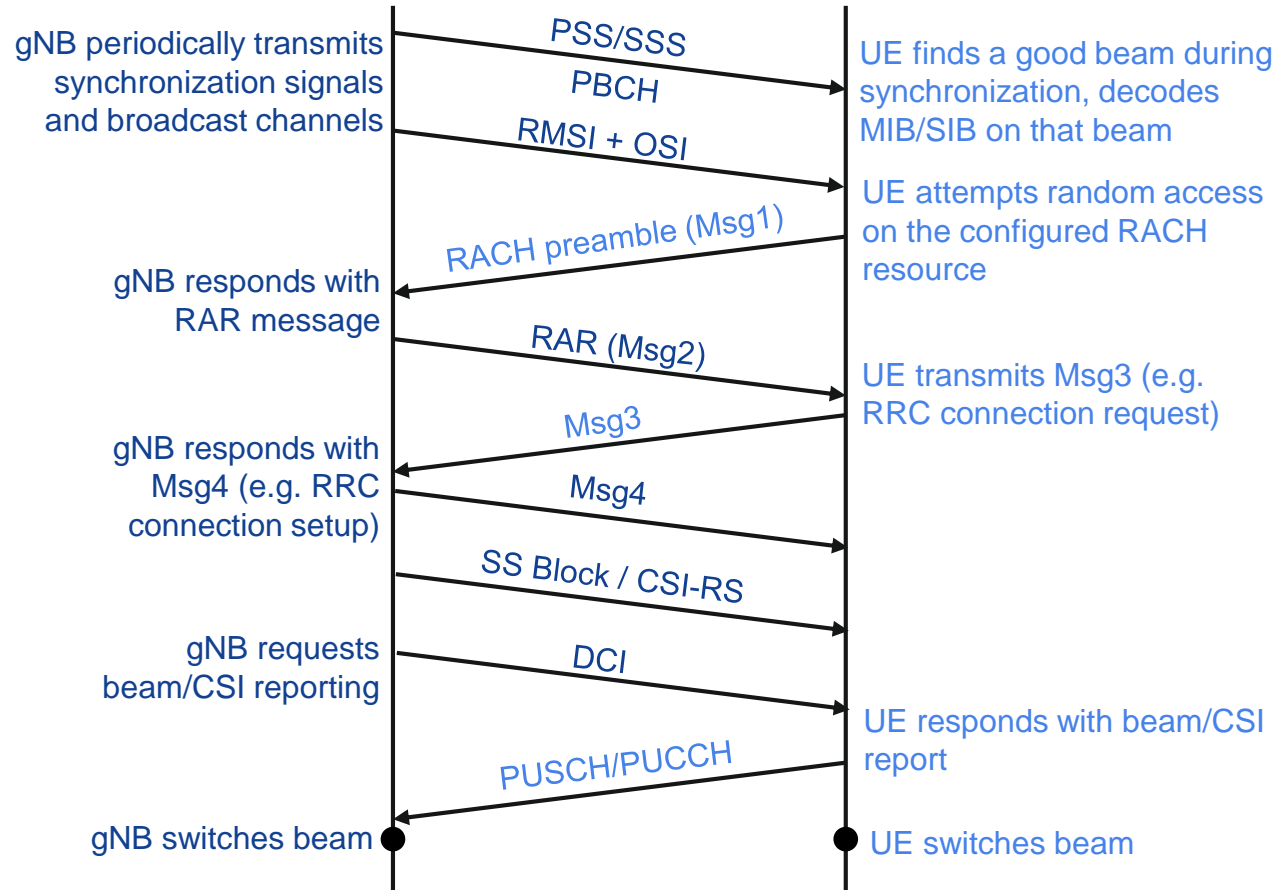

# Beam Management and CSI

## Downlink Codebook Overview

### Type I Codebooks:

- Standard resolution CSI feedback
- Single panel and multi-panel

### Type II Codebooks:

- High resolution CSI feedback targeting MU-MIMO
- Non-precoded and precoded CSI-RS
- Designed for cross-polar antennas

## Supported Antenna Ports

Ports	Type I		Type II	
	Single Panel	Multi-Panel	Non-precoded CSI-RS	Precoded CSI-RS
2	✓			
4	✓		✓	✓
8	✓	✓	✓	✓
12	✓		✓	✓
16	✓	✓	✓	✓
32	✓	✓	✓	✓



# Beam Management and CSI

## Codebook Comparison

### Type I Single Panel Codebook:

- SU-MIMO/MU-MIMO
- 1-8 MIMO layers
- Two-stage:
  - WB beam group selection (1 and 4 beam configurations)
  - SB beam selection and co-phasing
- Precoded & non-precoded CSI-RS supported

### Type I Multi-Panel Codebook:

- Builds on single panel codebook (1 beam), adding inter-panel co-phasing
- 1-4 MIMO layers
- Supports 2 or 4 antenna panels
- Low and high resolution SB co-phasing is available with 2 panels

### Type II Non-precoded CSI-RS Codebook:

- Forms a linear combination of 2, 3, or 4 DFT beams selected from an orthogonal basis
- WB beam amplitudes, SB phase, optional differential SB amplitudes
- 1-2 MIMO layers

### Type II Precoded CSI-RS Codebook:

- Selects a subset of the beamformed ports and forms a linear combination of the selected beams
- WB beam amplitudes, SB phase, optional differential SB amplitudes
- 1-2 MIMO layers

# CSI Feedback

## mmWave

For mmWave:

- Use beam management to select the best beam for each UE
- Apply the Type I single-panel codebook to select the transmit weights

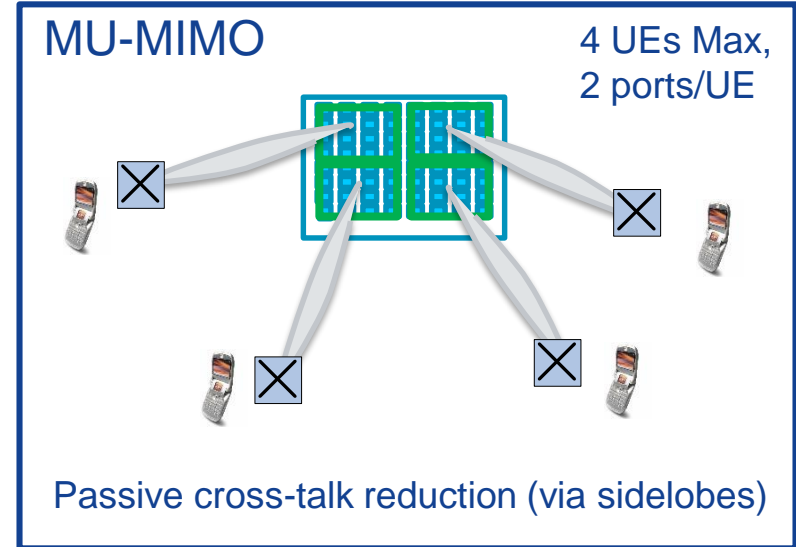
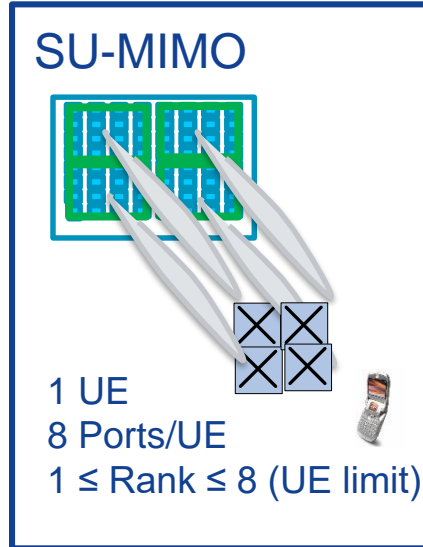

## CSI Feedback

### DL Codebook Overhead Example

Type I		Type II			
Single Panel	Multi-Panel	Non-precoded		Precoded	
L=2: 9/1	Mode 1: 10/1	L=2:	31/12-24	L=2:	25/12-24
L=4: 7/3	Mode 2: 10/3	L=4:	59/28-48	L=4:	51/28-48

M/N indicates M wideband bits and N bits per subband (Type II entries indicate the range of possible bits per SB)

- L – Number of beams configured in the codebook
- 16 ports, 2 layers assumed
  - Single panel and non-precoded:  $N_1=4$ ,  $N_2=2$
  - Multi-panel: 2 panels,  $N_1=2$ ,  $N_2=2$
  - Precoded: Selection sampling factor ( $d$ ) = 1

**NOKIA**

# mmWave Performance



# Early 5G use case: Extreme broadband to the home (mmWave)



5G RAN & EPC

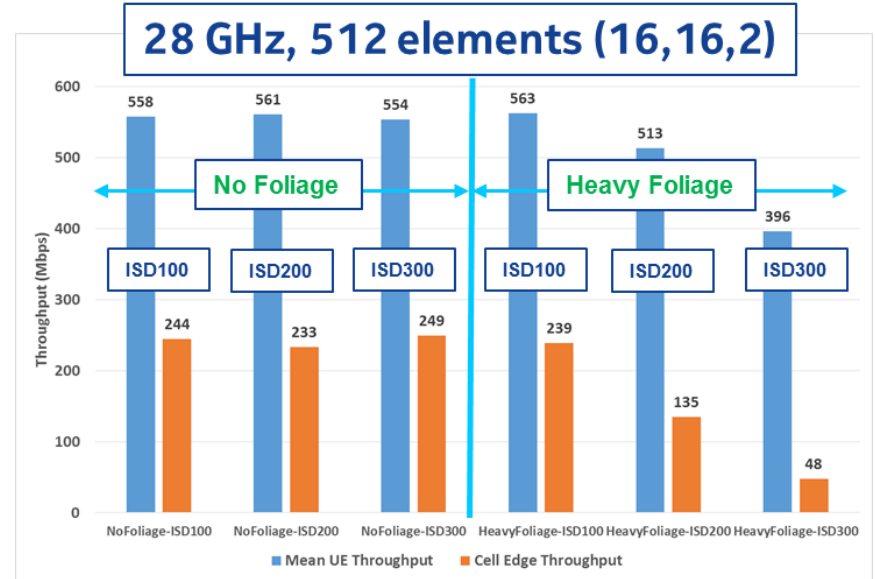

# Antenna Array Comparisons - AP Antenna Aperture Constant vs. Frequency

5dBi ant element gain, 7dBm AP Pout per element, 1dBm UE Pout per element, shown to scale

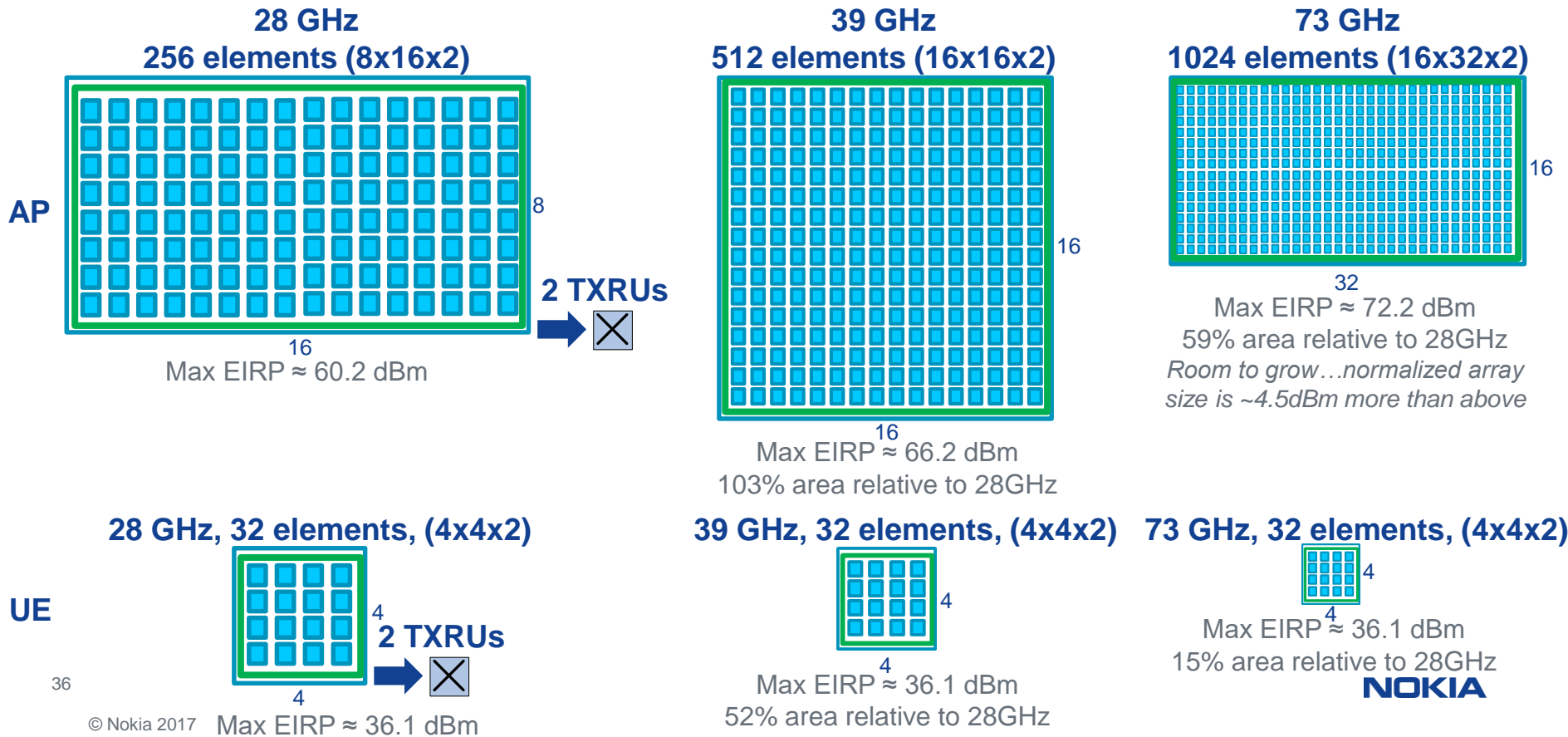



# System Simulation Results for the Suburban Micro Environment

## Constant Antenna Aperture for 28 GHz, 39 GHz and 73 GHz

### Mean UE Throughput

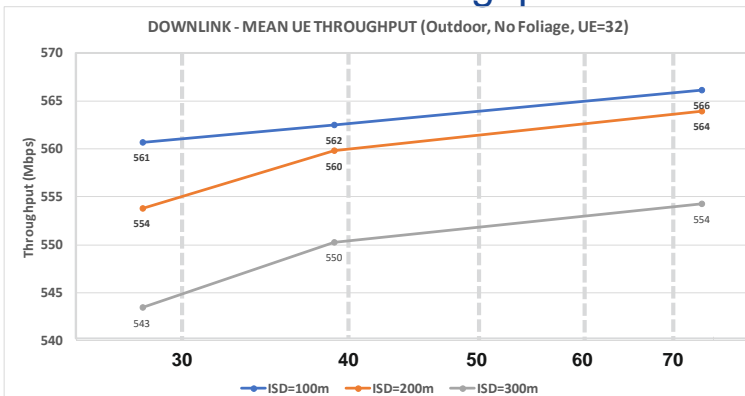

### Cell Edge Throughput

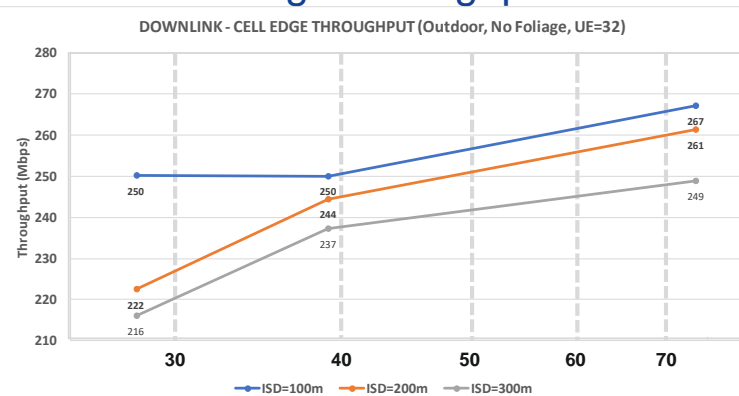

### Uplink - Mean UE Throughput

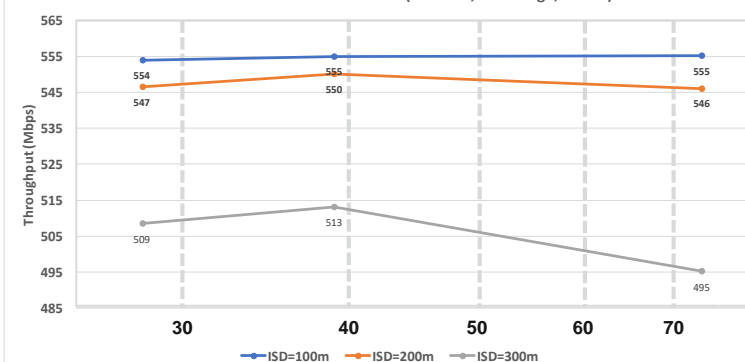

### Uplink - Cell Edge Throughput

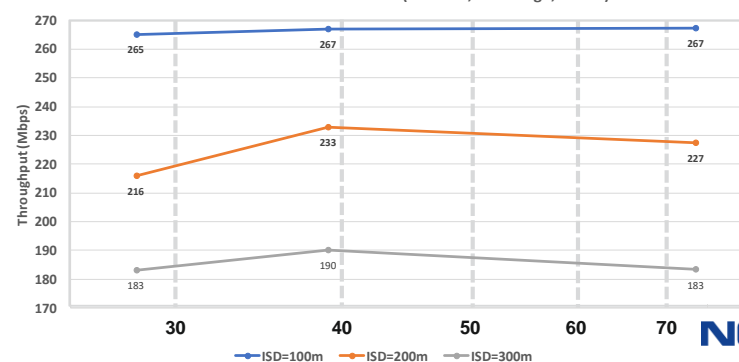

Downlink

Uplink

# System Simulation Results

## Summary

- Antenna array size will decrease for given array configuration and number of elements
  - Reduced antenna aperture is the primary reason for decreasing performance with higher frequency
  - Little degradation is seen at 100m ISDs as systems are not path loss limited
  - Some degradation is seen for larger ISDs as systems become more noise limited
- Keeping antenna aperture constant can mitigate differences at higher frequencies
  - Increasing the number elements as frequency increases will keep the physical array size and antenna aperture constant
  - Performance is nearly identical at all frequencies and ISDs with constant physical array size (antenna aperture)
  - Slight improvements in downlink performance if power per element is held constant as number of elements is increased
- Foliage poses challenges at all mmWave frequencies and is not dramatically higher at 70 GHz as compared to 28 GHz or 39 GHz

**NOKIA**

# Self Backhauling and PoC



# Basic Network Building blocks

- 5G mmW basestation and integrated wireless backhaul will be a small box which is easy to install to lamp posts, walls or small masts.
- The cost of the box is mainly in RF, antennas and BB-SoC, of course some cost goes for cover mechanics and power supply.
- Investigating how to arrange the creation and manufacturing of the RF and antenna components.
- Multi-sector sBH is the assumption

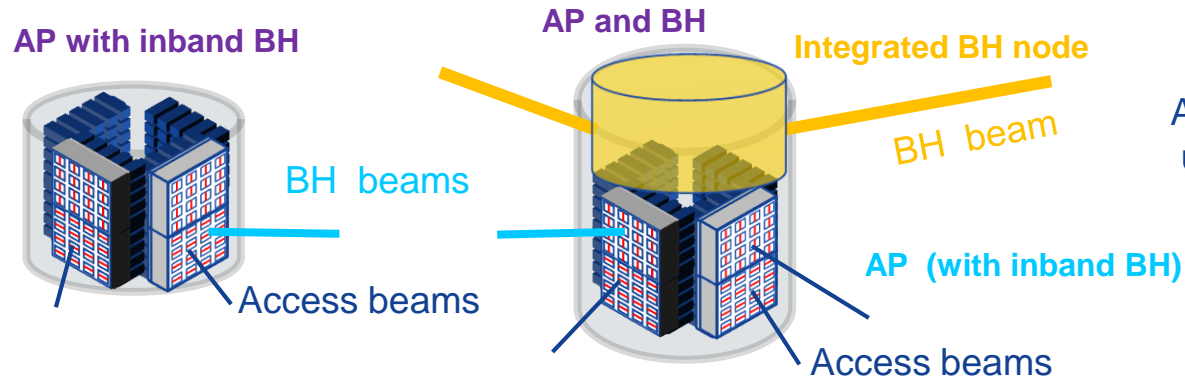
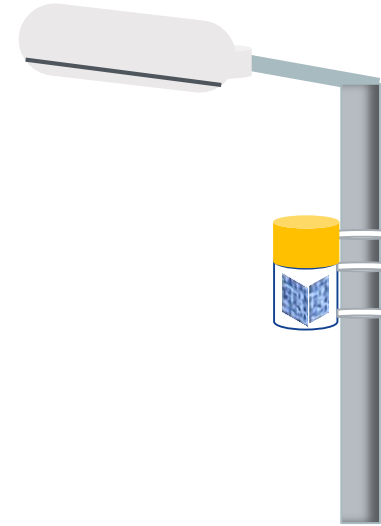

AP and Integrated BH use quite similar technologies

# Self-backhauling Needed for Millimeter Wave Cellular

- New radio would likely require **dense deployments right from the initial phases** to get sufficient coverage (esp. for frequency > 20 GHz).
- Economically not feasible to provide fiber connectivity to each site until the new radio deployments become mature.
- Self-backhauling is enabling multi-hop networks with shared access-backhaul resources.

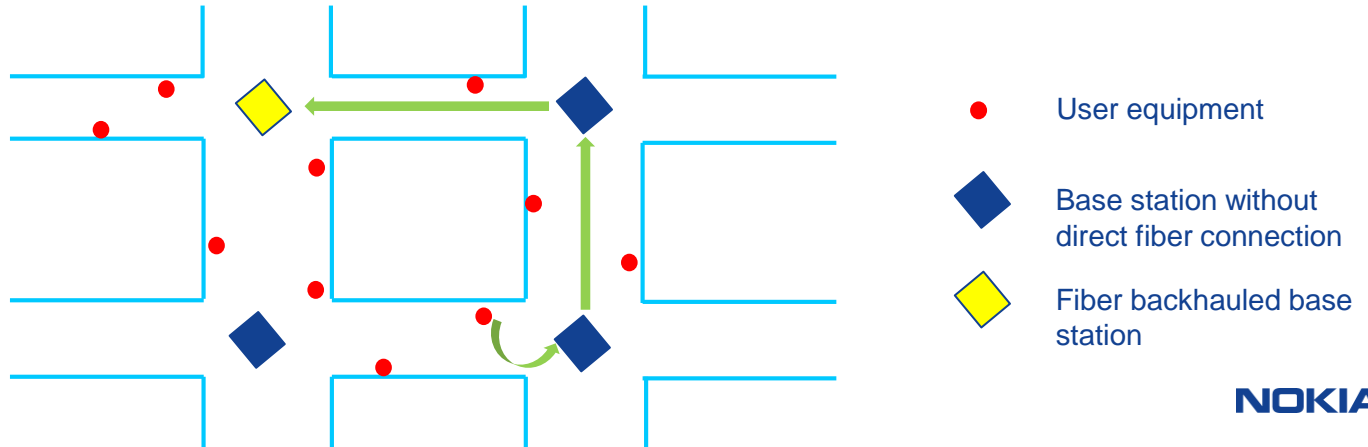

# Comparison of Rates: 3MB scenario

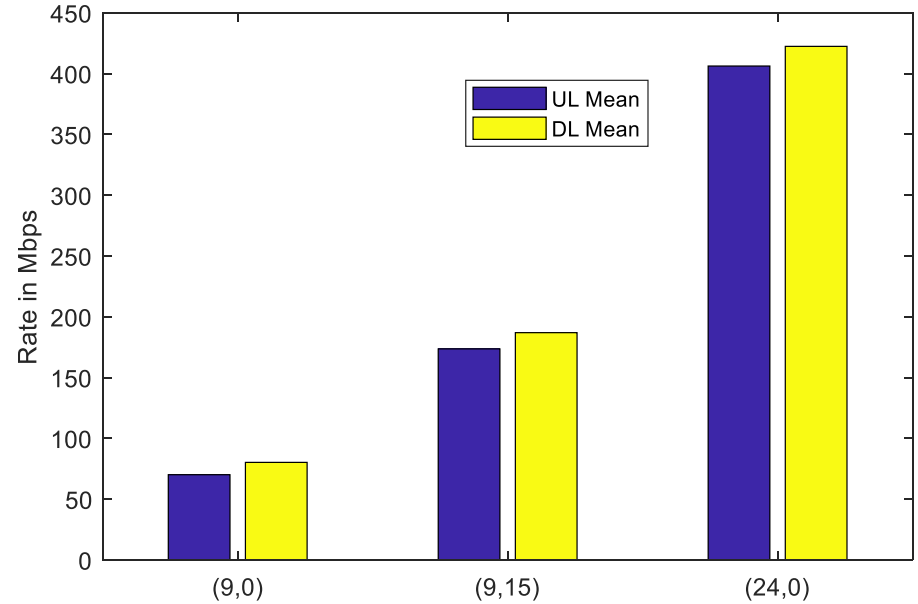
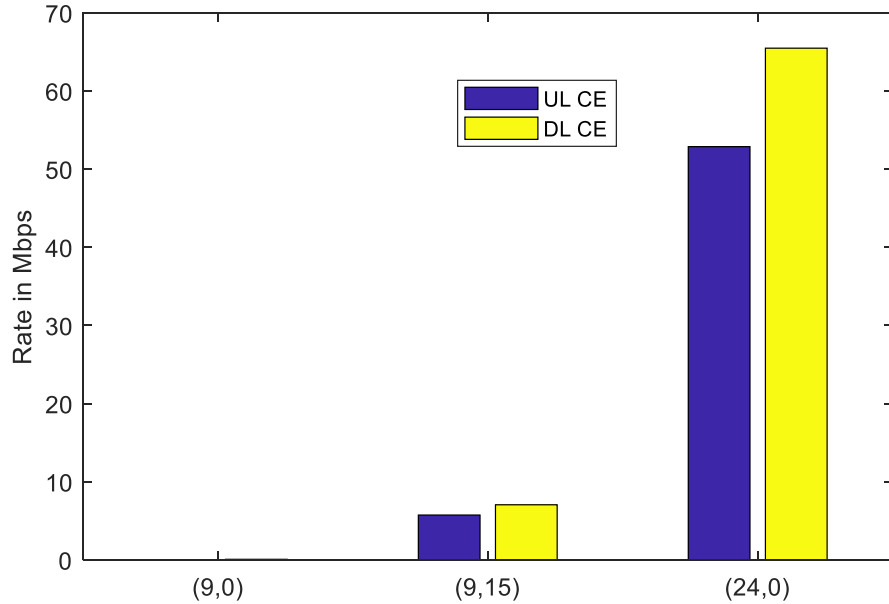

More than **100x** gain in cell edge rates and about **2x to 3x** gain in mean rates by adding 15 relays to (9,0)



# 5G mmWave Proof-of-Concept @70 GHz

## Features

- 1) Feature 1: 1 GHz BW Single Link @ 70 GHz**
  - Single-user acquisition and tracking Collaborate on field testing at YRP
  - Mobile World Congress 2015
- 2) Feature 2: 1 GHz BW Multi Link @ 70 GHz**
  - Low latency application support < 1 ms
  - Multi-user acquisition and tracking
  - Dynamic TDD allocation
  - Rapid Rerouting – Access Point Diversity
- 3) Feature 3: 2 GHz BW @ 70 GHz**
  - BBU based on new platform
  - 2x2 MIMO with 64 QAM modulation
  - Peak Rate : 15 Gbps

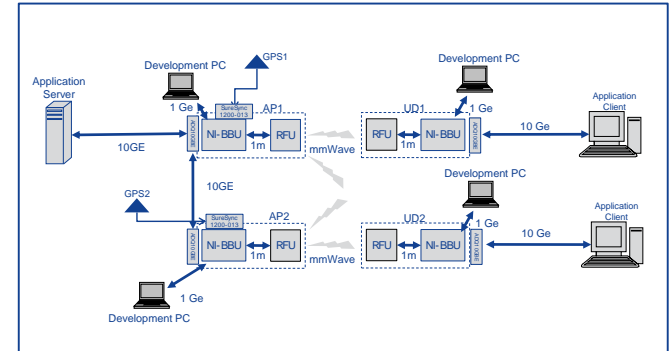

# Nokia 5G mmWave beam tracking demonstrator (70 GHz)



## 70 GHz PoC System

- 1 GHz BW (2.5 Gbps Peak Rate)
- 2 GHz BW (2x2 MIMO, 15 Gbps Peak Rate)

Mobile device

Beam tracking the mobile

Access point

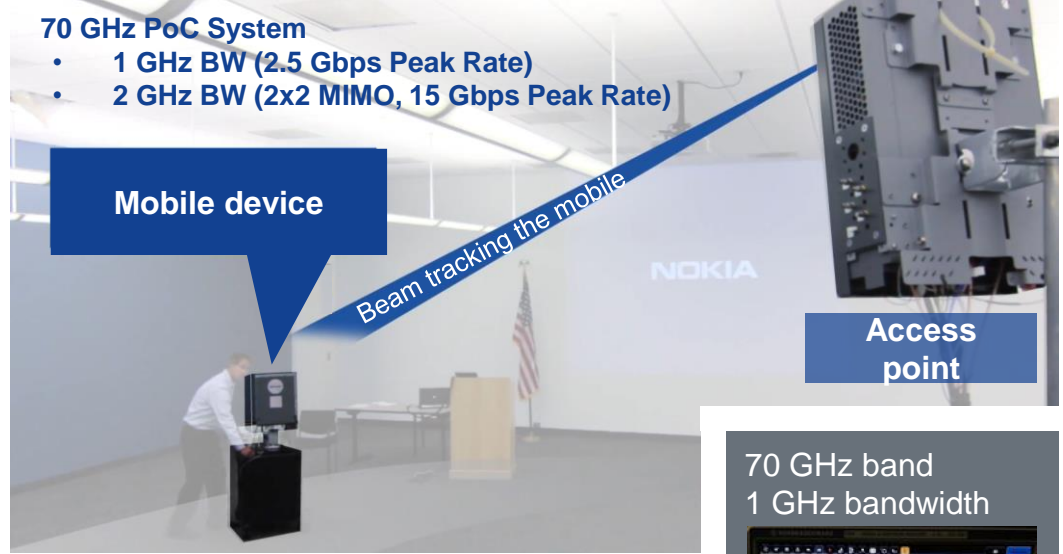

Lens antenna with  
64-beam  
switching

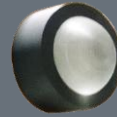

3° beam  
width

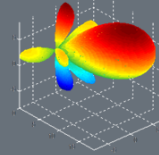

70 GHz band  
1 GHz bandwidth



# Nokia 5G mmWave beam tracking demonstrator (70 GHz)

## Rapid Rerouting Feature

- **Scenario: 2 APs and 1 UD**
  - APs are configured for overlapping coverage creating a triangle between AP1, AP2 and the UD
  - UD is positioned such that it can detect both APs. UD will display the detected beams from both APs. The UD will maintain connectivity to both the serving and alternate AP.
- **TCP/IP throughput**
  - Iperf application running over the mmWave will be used to demonstrate throughput
  - The throughput will be displayed on the User Device (UD) display showing the raw of PHY throughput of 2 Gbps.
  - Rapid re-routing between APs will show minimal TCP/IP throughput degradation depending on type of re-route.
- **Rapid Rerouting demonstrations:**
  - **Blockage Detection (BD):** Serving AP is blocked by demonstrator using a mmWave opaque device (many different physical items are suitable).
  - **Make Before Break (MBB):** UD is rotated slowly to favor the alternate AP initiating a re-route.
  - **Break Before Make (BBM):** An abrupt change where both APs are blocked and the UD must re-initialize the connection.

# mmWave Rapid Rerouting

## Blockage Detection

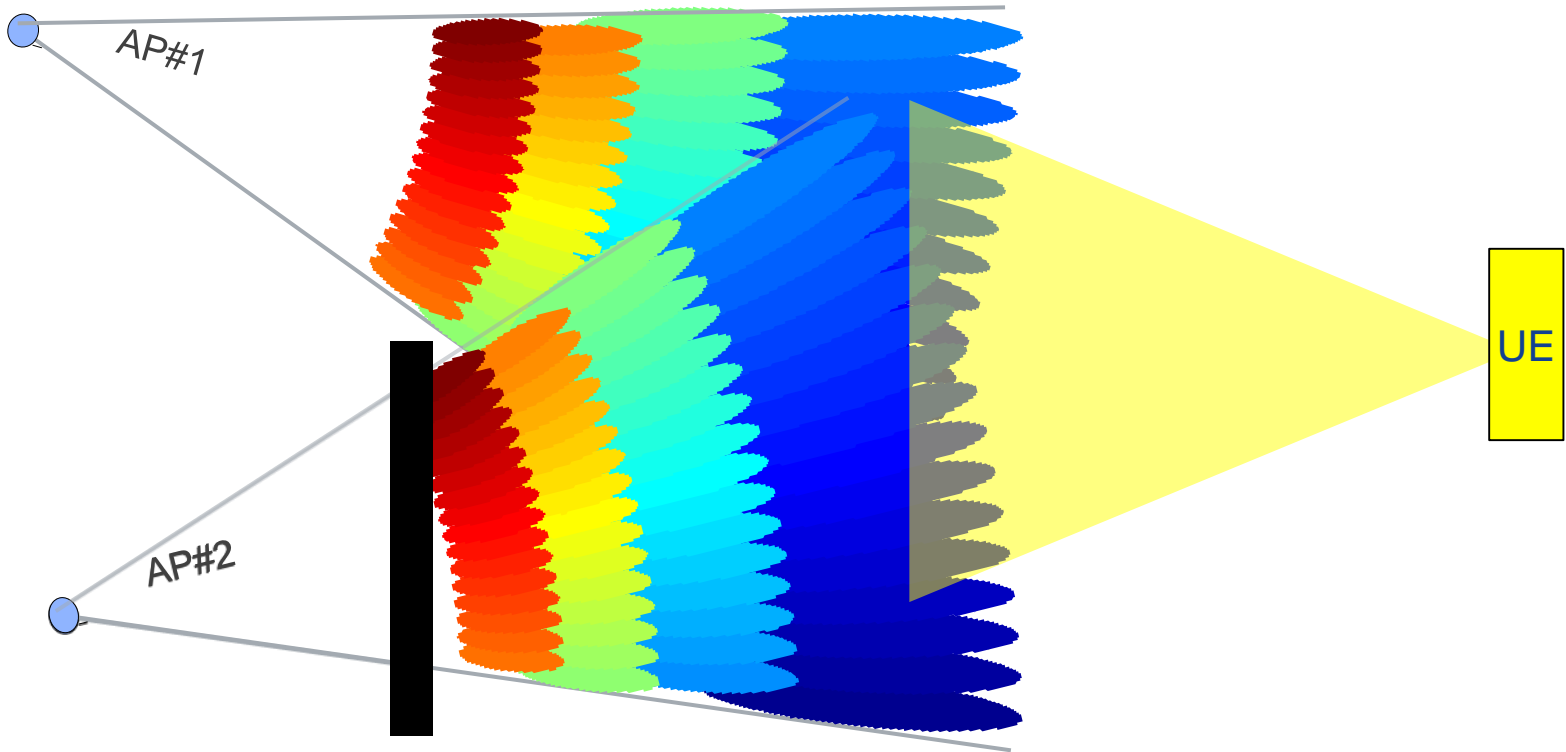

# mmWave Rapid Rerouting

## Demo Display – “Main 2” tab

- New “Main 2” Tab
  - Main 2 can be used for demonstrations showing physical layer throughput, serving cell and detected beam SNR
- Throughput Gauge
  - Duplicated from the “Main” tab shows the downlink throughput of the UD visible to observers. Throughput and active MCS are visible below in text.
  - Reflects the application throughput running over the link. Recommend Iperf session running over the mmWave link
- SNR (per Beam per Cell)
  - Shows the beam SNR per cell for all 64 beams: 16 QAM 7/8 is in red; 16 QAM 1/2 is in yellow, QPSK 1/2 is green and BPSK 1/5 is blue. Undecoded beams are left blank
  - The serving cell is identified by the text “SERVING” and by a blue border
- Blockage Detection
  - When the UD RRC detects an abrupt drop in detected beams, the link will be rerouted and the “Block Detected!” LED will be illuminated for 1 second.

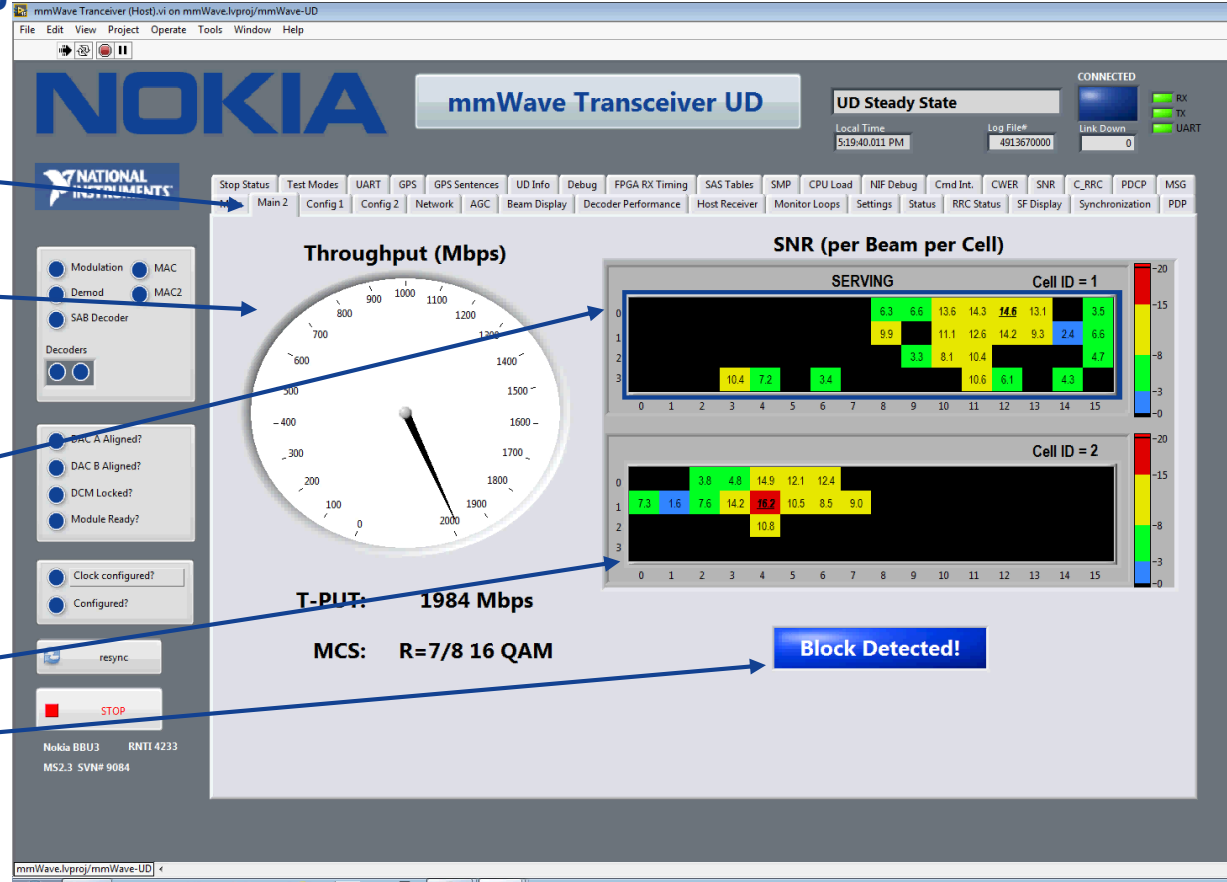

# Contributors

Mark Cudak, Fred Vook, Rapeepat Ratasuk, Jie Chen, Bill Hillery, Jun Tan, Eugene Visotsky, Jun Tan, Frank Hsieh, Karri Ranta Aho, Mandar Kulkarni, Nokia PoC Team, Nokia Standards Team, National Instruments



Q&A